

konektor X1

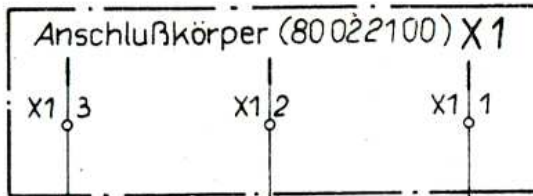

umístění kontaktů zásuvky X1
Anschlußbelegung
des Steckerkasten X1

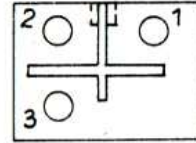

M1/2

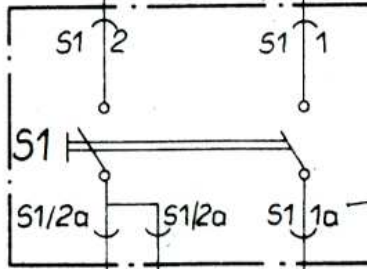

kolébkový spínač
Wippenschalter (80 02 19 80)

M1/1

E1/1

E1/2

Einbaumotor
2-polig

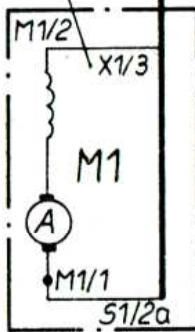

vestavěný motor dvoupólový

Nählicht

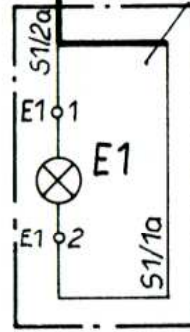

šicí světlo

Schéma propojení

Anschlußplan
80 02 21 06

Modelle

- 4522
- 4532
- 4512
- 4502

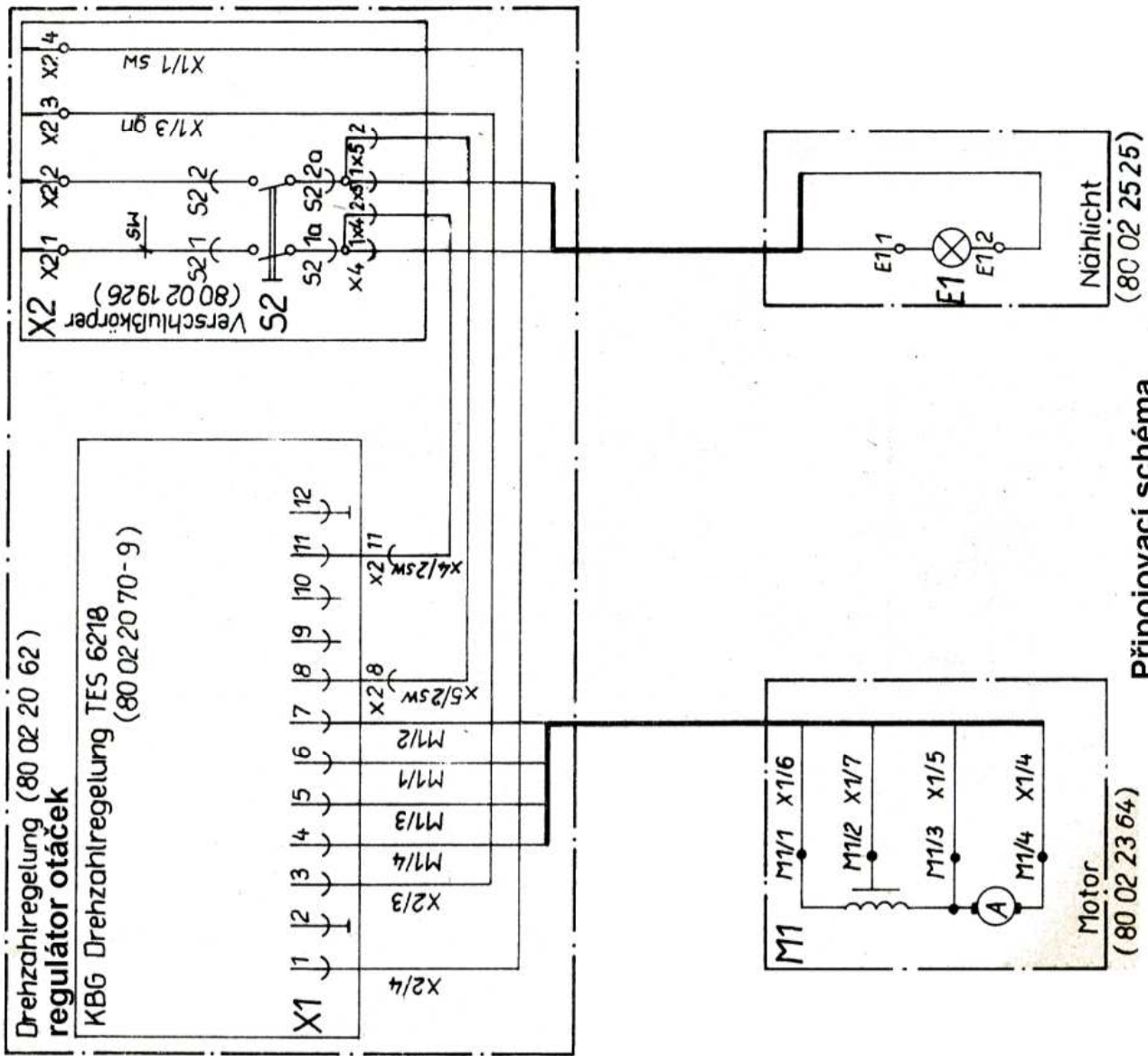

Anschlußbelegung
des Steckerkasten X2

umístění kontaktů
zásuvky X2

Modelle

- 4521
- 4531
- 4511
- 4501

Připojovací schéma
Anschlußplan
80 02 20 66

polohování jehly

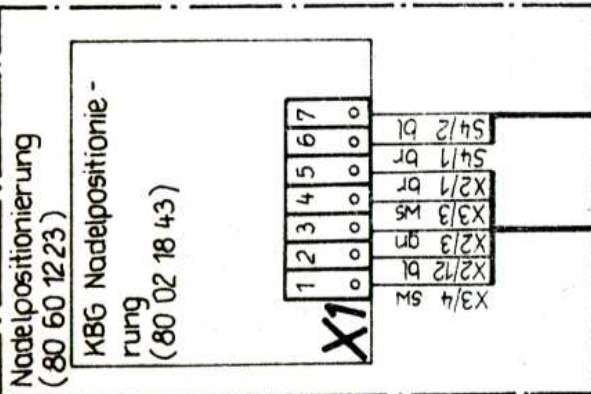

regulace otáček

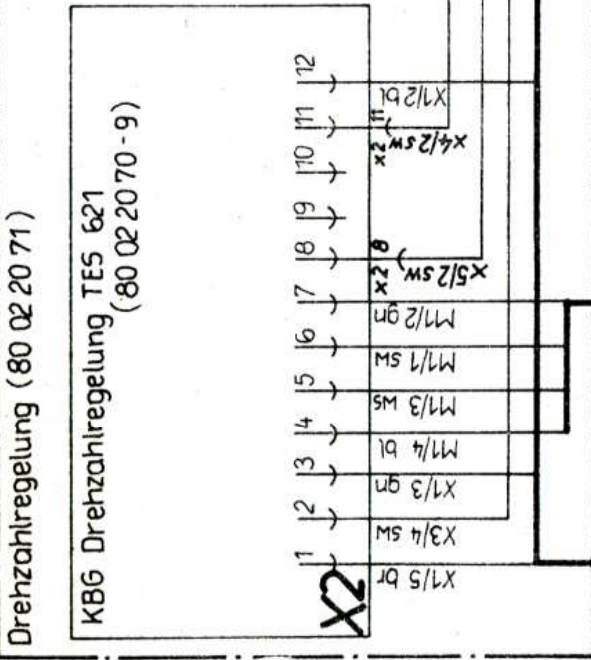

těleso uzávěru

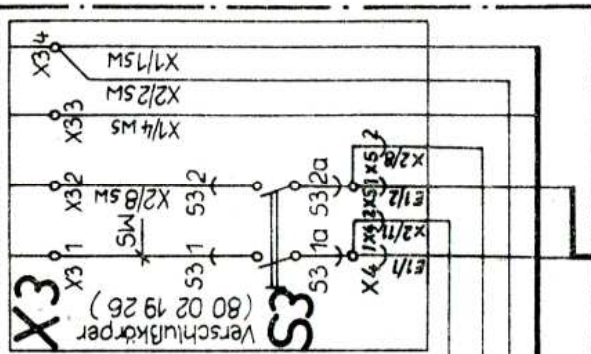

Anschlußbelegung
des Steckerkasten

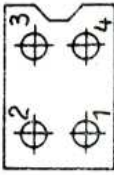

X3

Leitung (80 02 20 87)

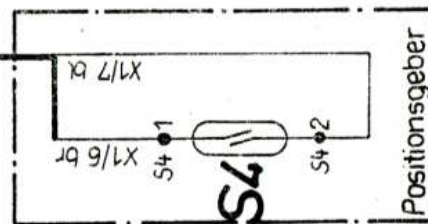

čidlo polohy

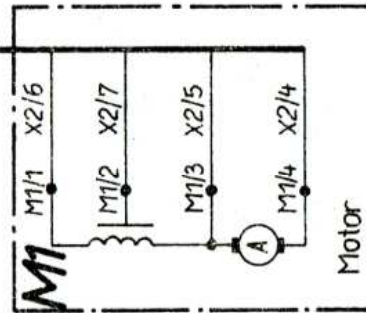

Anschlußplan
80 02 20 85

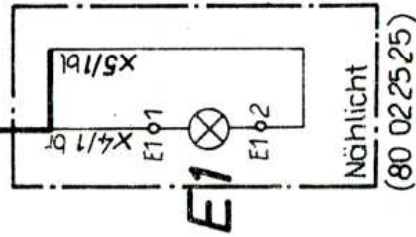

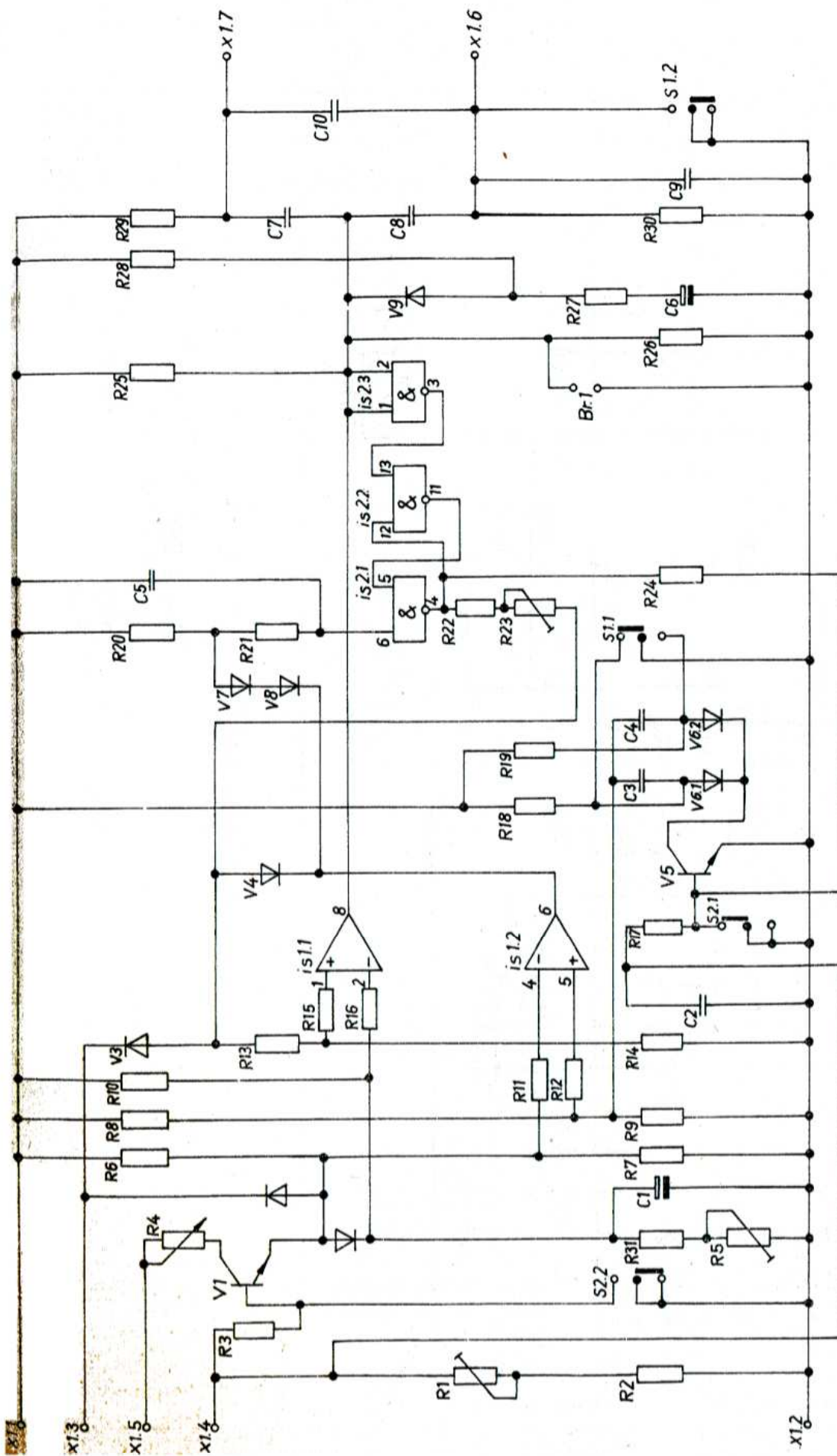

Stromlaufplan (Nadelpositionierung)
 Wiring diagram (needle positioning)
 Schéma des connexions (positionnement de l'aiguille)
 Overzicht van het stroomverloop (naaldstandzoeker)
 План прохождения тока (механизм позиционирования иглы)
 Plán rozvádění proudu (polohování jehly)
 Huzalozási vázlat (tűpozicionálás)

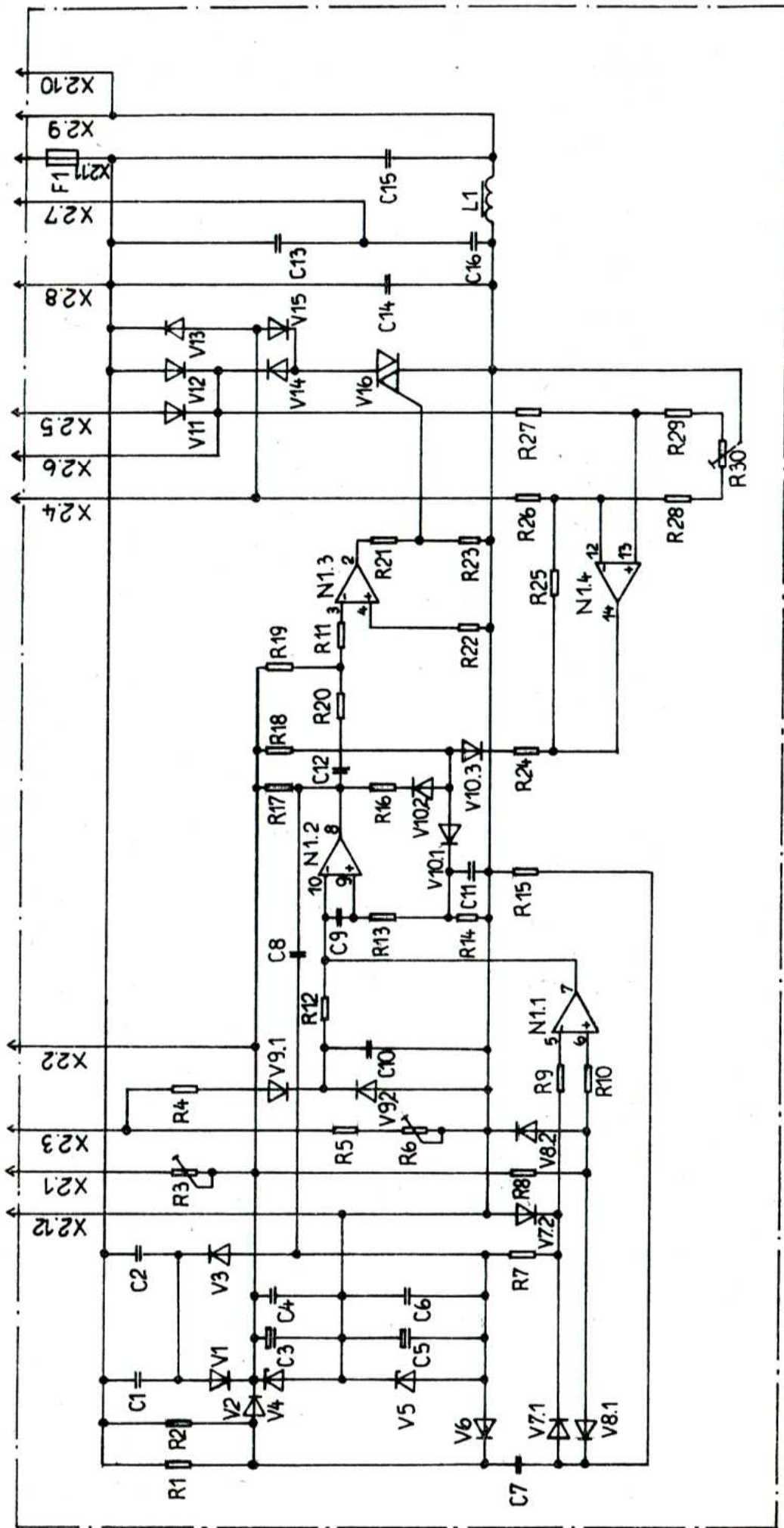

Stromlaufplan (Drehzahlregelung E2)

Wiring diagram (speed control E2)

Schéma des connexions (Regulateur de vitesse E2)

Overzicht van het stroomverloop (Toerentalregeling E2)

План прохождения тока (управление числом оборотов для E2)

Plán rozvádění proudu (Regulace otáček motoru E2)

Huzalozási vázlat (fordulatszám-szabályozó E2)